

F
E
D
C
B
A

8 7 6 5 4 3 2 1

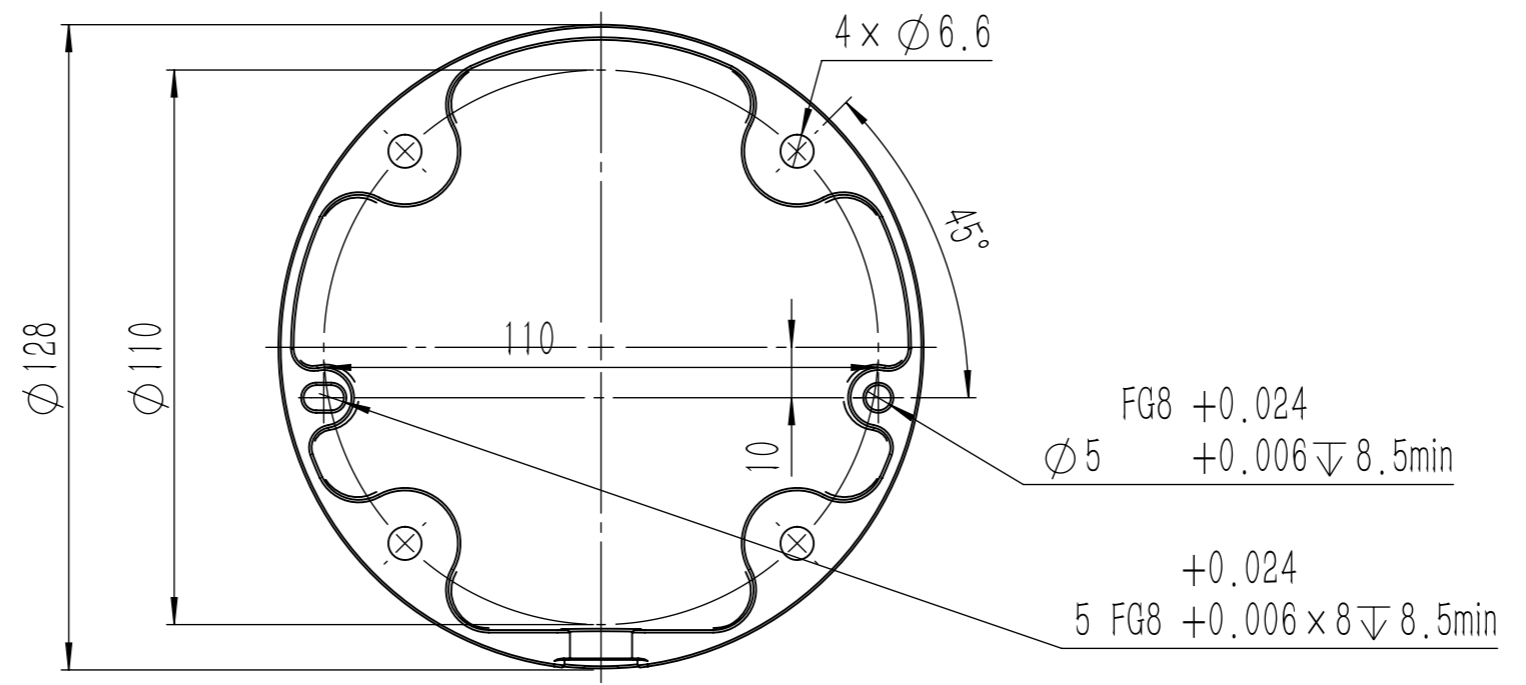
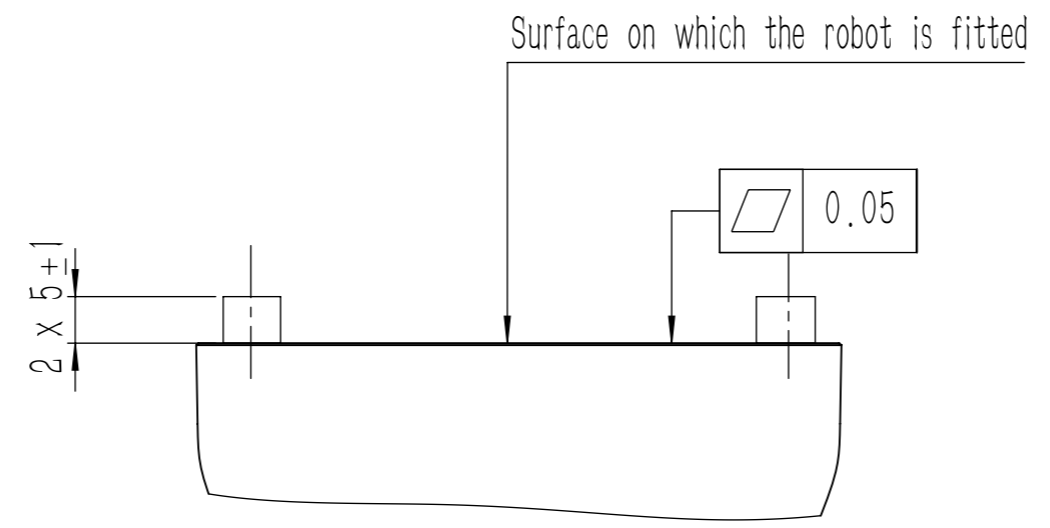

TITLE		CS63 Base installation drawing	
DATE		5-19-2023	
REV.	1.1	NO.	T202208003

8 7 6 5 4 3 2 1